

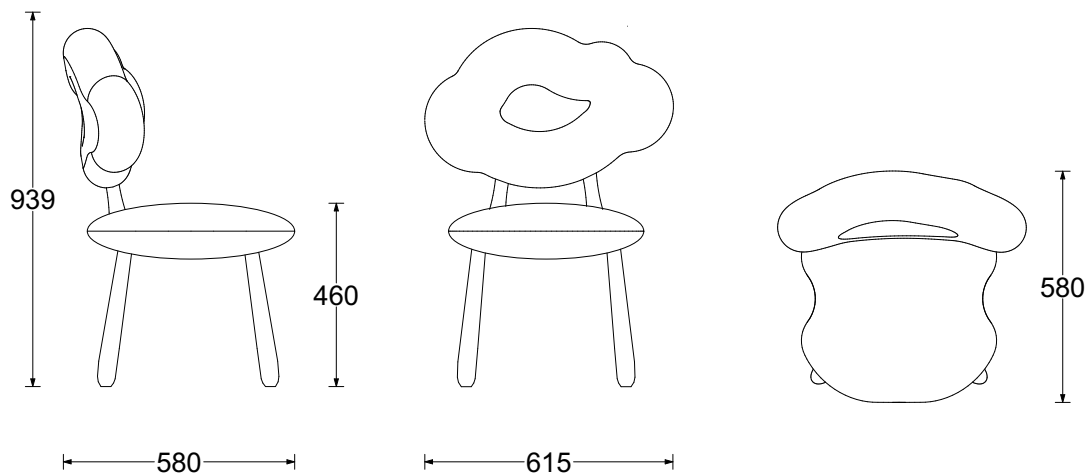

NIMBUS CLOUD CHAIR

DIMENSIONS	FABRIC FOR COM	LEAD TIME
in W. 24.2 x D. 22.8 x H. 35.6 / Seat height 18.8 cm W. 61.5 x D. 58 x H. 90.4 / Seat height 48	1.7 mts	12 weeks



WOOD STRUCTURE



OAK

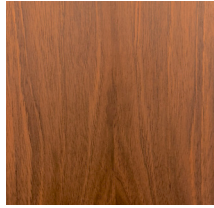

WALNUT

UPHOLSTERY - ELLA / AMANDA

52% Viscose, 26% Cotton, 22% Linen.

Width : 138 cm / 54.0 in Martindale : 35.000

100% Polyester FR.

Width : 138 cm / 54.0 in Martindale : 35.000



CENDRE

ED-E-FAELL-009



ECORCE

ED-E-FAELL-010

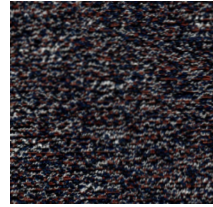

ABYSSE

ED-E-FAAMA-023



TOMETTE

ED-E-FAAMA-024

UPHOLSTERY - AVA

33% Viscose, 24% Virgin wool, 24 % Polyacrylic, 12% Linen, 6% Polyester, 1% Polyamide.

Width : 146 cm / 57.4 in Martindale : 80.000

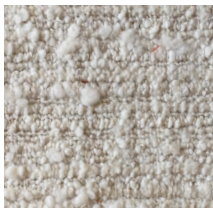

ECRU

ED-E-FAAVA-013

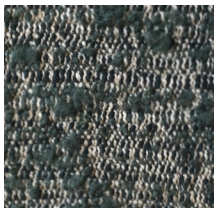

EMERALD

ED-E-FAAVA-014

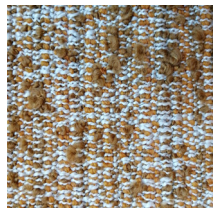

HONEY

ED-E-FAAVA-015



GREY

ED-E-FAAVA-016

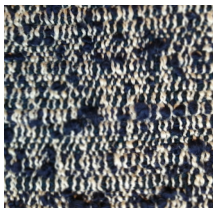

DARK INDIGO

ED-E-FAAVA-017



AQUA

ED-E-FAAVA-018